

FANOX

CONTROLADOR DE TEMPERATURA FANOX TP 750



Contenido del embalaje:

- » Controlador PID,
- » Cubierta trasera.
- » Grapas de amarre.
- » Perfil de goma.
- » Manual de usuario.

Gracias por adquirir este producto. Le sugerimos que lea detenidamente el manual de usuario antes de usar el equipo con el fin de familiarizarse con su configuración y funcionamiento. Guarde el manual para consultas posteriores.

www.fanox.com

DIMENSIONES / CORTE

Unidad: mm

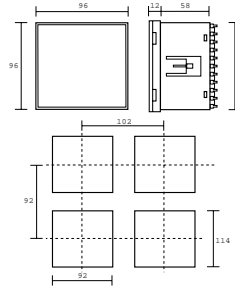

ADVERTENCIA

- » Asegúrese de apretar correctamente los terminales de conexión. Si esto no se hace de forma adecuada pueden ocasionarse fallos mecánicos e incluso fuego.
- » Por favor, no instale este equipo en ubicaciones donde puedan existir gases inflamables, ya que puede existir riesgo de explosión.
- » La vida del equipo depende del modo de empleo. Si ese tiempo de vida es superado aumenta la probabilidad de que el equipo se deteriore.
- » No desmonte, revise o repare el equipo por su cuenta y sin autorización. Esto puede causar cortocircuitos en los aparatos eléctricos, fallos o fuego.
- » No introduzca elementos metálicos entre los chips del interior del equipo ya que pueden producir cortocircuitos o fuego.

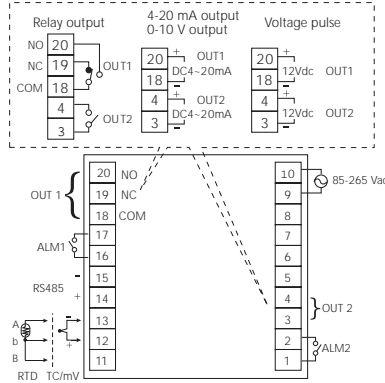

PRECAUCION

Por favor, lea detenidamente las siguientes advertencias, ya que le permitirán realizar un uso correcto del equipo:

- » Use el equipo dentro de los límites especificados para su inmersión en agua y exposición a aceite.
- » No use el equipo en ubicaciones expuestas a vibraciones o golpes. El uso del equipo en dichas ubicaciones puede ocasionar daños debidos a estrés.
- » No use el equipo en ubicaciones expuestas a polvo, gases corrosivos o sol directo.
- » Separe los dispositivos de señal de entrada, los cables de señal de entrada y el equipo de fuentes de ruidos o cables de alta tensión que generen ruidos.
- » Separe el equipo de fuentes de electricidad estática cuando use el equipo en ambientes donde se genera gran cantidad de electricidad estática (p.e. fabricación de compuestos, polvos o transporte por tuberías de materiales fluidos)
- » Las soluciones orgánicas así como soluciones ácidas o básicas podrían dañar la envolvente exterior del controlador de temperatura.
- » Almacénelo a la temperatura especificada. Si el controlador de temperatura ha sido almacenado a temperaturas menores de -10 °C, mantenga el equipo a temperatura ambiente durante un mínimo de 3 horas antes de usarlo.

Por favor, compruebe las características de la alimentación del equipo. No conecte los terminales que no vayan a ser usados.

Le proponemos que emplee cables AWG 18-24 para la línea de señal y AWG 25-30 para el cable de alimentación y el relé de contacto de salida.

ESPECIFICACIONES

- Alimentación:** 85-265 Vca, 50/60 Hz
Display: Display superior (rojo): 4 dígitos 0,56" 7 segmentos
 Display inferior (verde): 4 dígitos 0,36" 7 segmentos
 Termopar: J, K, B, N, R, S, T, E
 RTD: PT100, JPT100
 Tensión CC: 0-350 mV
Salida de control: Relé de salida (resistiva) SPDT-NA, 5A/250 Vca
 Salida pulso de tensión (SSR) NPN, 20 mA a 12 Vcc
 Salida analógica (max. 6000): 4-20 mA, 0-10 Vcc
 SPST-NA, 3A/250 Vca (resis.) 00-99 s
Relé de alarma: Salida RS485
Tiempo de retraso: 0-999,9 °C (°F)
Histéresis: Salida RS485
Comunicación: 0-50 °C (20-85 % HR)
Ciclo control de salida: 0-999,9 s
Punto decimal: 0-3 dígitos
Filtro digital: 1-100
Método de control: ON/OFF o PID (Autotuning)
Offset de entrada: -199,9-999,9
Valor de fracción: 0000-9999
Rango de ajuste: -1999-9999
Precisión: ± 0,3 % ± 1 dígito
Tiempo muestreo: 200 ms
Memoria: EEPROM

PANEL FRONTAL

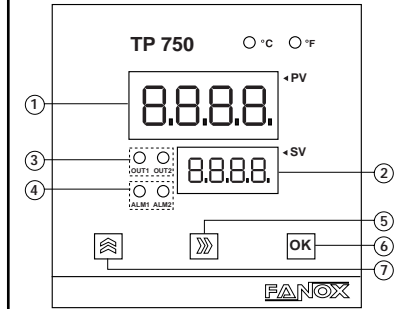

- 1 Valor de proceso y visualización de funciones: LED rojo de 7 segmentos.
- 2 Valor de ajuste y visualización de parámetros: LED verde de 7 segmentos.
- 3 Indicación del control de salida.
- 4 Indicación de alarmas
- 5 Tecla: [Retrosceso] Retroceder a un nivel superior y sumar.
- 6 Tecla: [OK] Navegar en un nivel y confirmación.
- 7 Tecla: [Avance] Avanzar a un nivel inferior y posicionar.

DIAGRAMA DE FLUJO DE AJUSTES DE PROGRAMACION

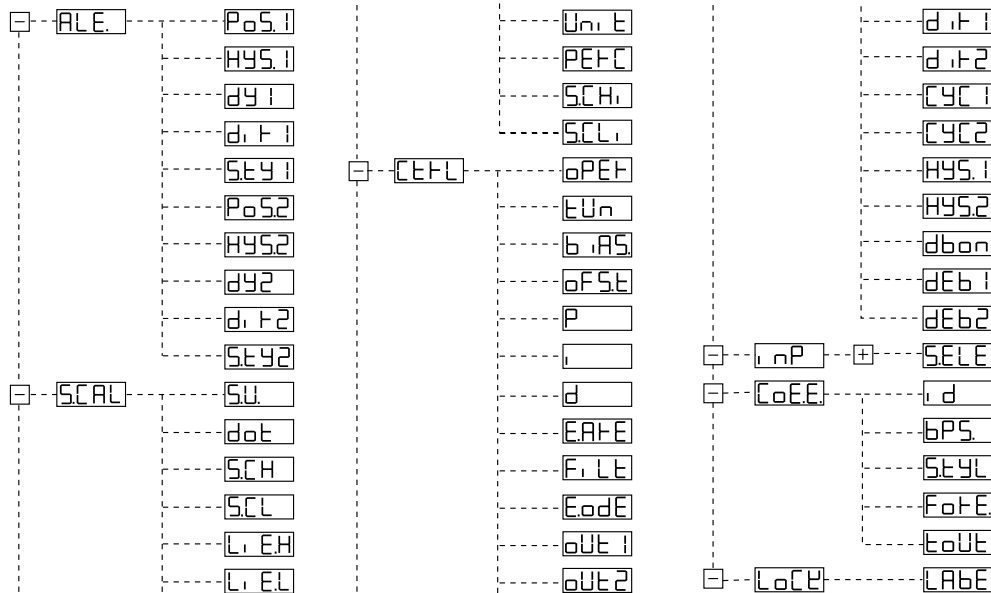

FUNCIONAMIENTO DE LOS BOTONES

Los ajustes en el equipo son controlados mediante 3 botones situados en el frontal. Primero debe decidir a que funcion desea acceder y luego, emplear los botones para llegar a ella. Los botones se emplearan de la siguiente manera:

	Selección	Ajustes
[Avance]	Avanzar un nivel inferior	Posicionar
[Retrosceso]	Retroceso a nivel superior	Sumar
[OK]	Navegar en un nivel	Confirmación

[OK] BOTON "OK"

- 1) Posibilita navegar en un menú.
- 2) Confirmación para salvar los ajustes.

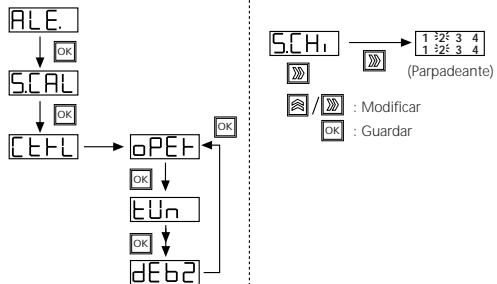

[Avance] BOTON "AVANCE"

Permite avanzar de un nivel superior a otro inferior.

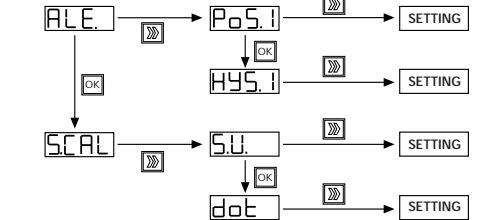

Igualmente, se utiliza para moverse entre las posiciones de los dígitos de un valor a cambiar.

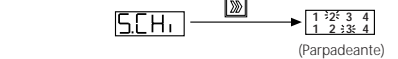

[Retrosceso] BOTON "RETROCESO"

Permite retroceder de un nivel inferior a otro superior:

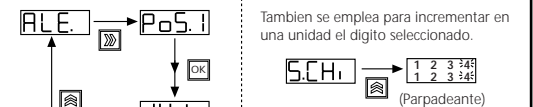

También se emplea para incrementar en una unidad el dígito seleccionado.

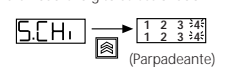

LISTA DE FUNCIONES

Item	Subitem	Rango	Defecto	Descripción
ALE.	PoS1	-1999-9999	0	Posición relé alarma 1
	HYS1	0000-9999	0	Histéresis relé alarma 1
	dY1	00-99	00 s	Retraso relé alarma 1
	d.F1	H/L0	H1	Dirección relé alarma 1
	SEY1	SE1-SE8	SE1	Estilo relé alarma 1
		SE9		Alarma sigue la salida 1
		SE10		Alarma sigue la salida 2
	PoS2	-1999-9999	0	Posición relé alarma 2
	HYS2	0000-9999	0	Histéresis relé alarma 2
	dY2	00-99	00 s	Retraso relé alarma 2
SCAL	SU	-1999-9999	0	Valor de ajuste SV
	dot	dot0-dot3	dot1	Ajuste punto decimal
	SCH	-1999-9999	9999	Valor límite superior escala
	SCl	-1999-9999	0	Valor límite inferior escala
	L.EH	-1998-9999	9999	Máximo valor del rango SV
	L.EL	-1999-9998	-1999	Mínimo valor del rango SV
	Un.t	oC/oF	°C	Unidades
	PEFC	on/off	OFF	Porcentaje
	SCHi	000.0-100.0	100	Límite superior entrada escala
	SCLi	000.0-100.0	0	Límite inferior entrada escala
CtFL	oPEF	Pi.d/onoF	ON/OFF	Operación
	tUo	tUn/off	OFF	Autotuning
	b.AS	-1999-9999	0	Ajuste de entrada PV
	oFSE	-1999-9999	0	Valor de offset del SV durante el autotuning
	P	0000-9999	3	Valor P
	I	0000-9999	200	Valor I
	D	0000-9999	20	Valor D
	EARF	0000-9999	0	Reset manual
	F.Lt	1-100	1	Filtro de entrada digital
	EodE	H-C	H-C	Mantener Tª por encima de la Tª del cuarto
oUt1	HEARt	HEARt		El calentador es controlado por la salida 1
	CoOL	CoOL		El enfriador es controlado por la salida 1
	HEARt	HEARt		El calentador es controlado por la salida 2
	CoOL	CoOL		El enfriador es controlado por la salida 2

Item	Subitem	Rango	Defecto	Descripción
CtFL	d.F1	H/L0	H1	Salida de control 1 directa / inversa
	d.F2	H/L0	H1	Salida de control 2 directa / inversa
	CYC1	0000-9999	5 s	Tiempo de ciclo 1 (segundos)
	CYC2	0000-9999	5 s	Tiempo de ciclo 2 (segundos)
	HYS1	0000-9999	0000	Histéresis de la salida de control 1
	HYS2	0000-9999	0000	Histéresis de la salida de control 2
	dbon	on/off	OFF	Control de banda muerta
	dEb1	-1999-9999	0	Parámetro de banda muerta del calentador
	dEb2	-1999-9999	0	Parámetro de banda muerta del enfriador
	i.nP	SELE	E EP	E EP
		J EP	J EP	Termopar tipo J (-210-1200 °C)
		T EP	T EP	Termopar tipo T (-200-400 °C)
		E EP	E EP	Termopar tipo E (-200-1000 °C)
		R EP	R EP	Termopar tipo R (-50-1760 °C)
		S EP	S EP	Termopar tipo S (-50-1760 °C)
		B EP	B EP	Termopar tipo B (250-1820 °C)
		N EP	N EP	Termopar tipo N (-200-1300 °C)
		PEEP	PEEP	Pt100 (-200-850 °C)
		JPEP	JPEP	JPT100 (-200-850 °C)
CoEE.	d	0000-0255	0001	Numero ID dispositivo
	bPS	600	9600	BaudRate : 600
		1200		BaudRate : 1200
		2400		BaudRate : 2400
		4800		BaudRate : 4800
		9600		BaudRate : 9600
		19200		BaudRate : 19200
		38400		BaudRate : 38400
	SEYL	8n1	8n1	8 bytes; no paridad; 1 bit stop
		8n2	8n2	8 bytes; no paridad; 2 bit stop
LoCE	FoFE	HEX	HEX	Hex
		ASC		Ascii
	LoUE	0100-9999	0100	Time Out / ms
	LAbE	L600	L600	Nivel de bloqueo 0
	L601		Nivel de bloqueo 1	
	L602		Nivel de bloqueo 2	
	L603		Nivel de bloqueo 3	

DESCRIPCION PARAMETROS

HYS Histéresis de salida de control	Se puede ajustar una histéresis alrededor del punto de ajuste para prevenir golpes bruscos
EARF Reset manual	En control PID, I=0, PV=SV, se resetea la salida de control al valor fijado en este apartado.
F.Lt Filtro de entrada PV	Esta función deberá ser usada cuando el valor de PV fluctúe ampliamente, debido a ruidos en la señal de entrada. Si un mayor tiempo constante es fijado, el filtro puede eliminar más ruidos.
CYCL Ciclo de tiempo salida de control	Repeticiones ON/OFF de una salida de relé o pulso de tensión en tiempo proporcional para control PID. El ratio ON es proporcional al valor de control de salida.
d.F Dirección del relé	Dirección del relé
LoCE Función bloqueo	Ajusta el bloqueo de las funciones que pueden ser mostradas y editadas.

MOTIVOS DE DISPARO

I	Display por encima de escala
F	Display por debajo de escala
0000	PV por encima de escala
UUUU	PV por debajo de escala
----	Rotura del sensor

AJUSTES EN MODO ALARMA

▲: SV △: Valor ajuste alarma ▼: Valor ajuste histéresis

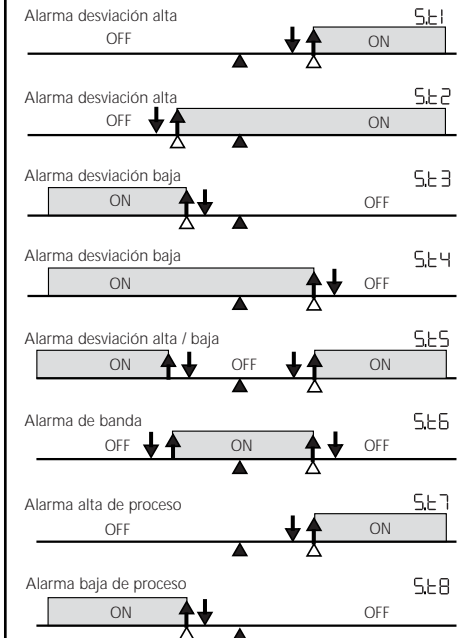

HISTERESIS

SV+dEb2	Cal.	Enf.
SV	X	0
SV+dEb1	X	X
	0	X

$$dEb1 < 0 ; dEb2 > 0$$

SV+dEb2	Cal.	Enf.
SV	0	0
SV+dEb1	0	0
	0	X

$$dEb1 > 0 ; dEb2 < 0$$

X: (Deshabilitado): Inhibe la salida.
O: (Habilitado): Permite a la salida de control seguir el algoritmo PID o ON-OFF

BLOQUEO DE FUNCIONES

LOCK	L603	L602	L601	L600
ALE.				
PoS1			0	0
HYS1				0
dY1				0
d.F1				0
SEY1				0
PoS2			0	0
HYS2				0
dY2				0
d.F2				0
SEY2				0
SCAL				
SU		0	0	0
dot				0
SCH				0
SCl				0
L.EH				0
L.EL				0
Un.t				0
PEFC				0
SCHi				0
SCLi				0
CtFL				
oPEF			0	0

LOCK	L603	L602	L601	L600
tUn			0	0
b.AS			0	0
oFSE			0	0
P			0	0
I			0	0
D			0	0
EARF			0	0
F.Lt			0	0
EodE			0	0
oUt1			0	0
oUt2			0	0
d.F1			0	0
d.F2			0	0
CYC1			0	0
CYC2			0	0
HYS1			0	0
HYS2			0	0
dbon			0	0
dEb1			0	0
dEb2			0	0
i.nP				
E EP				0
J EP				0
T EP				0

LOCK	L603	L602	L601	L600
E EP				0
T EP				0
S EP				0
B EP				0
N EP				0
PEEP				0
JPEP				0
dCEP				0
CoEE.				
d				0
bPS				0
SEYL				0
FoFE				0
LoUE				0
LAbE	0	0	0	0

FANOX ELECTRONIC
PAE. Asuaran, Edif. Artxanda, 23
48950 ERANDIO (Bizkaia) - ESPAÑA
Tel: +34 94 471 14 09 ; Fax: +34 94 471 05 92
www.fanox.com

FANOX

TEMPERATURE CONTROLLER FANOX TP 750

- Packaging content:**
- » PID Controller.
 - » Back cover.
 - » Brackets.
 - » Rubber outline.
 - » User manual.



Thank you for purchasing this product. We suggest to read the user manual carefully before using the equipment with the purpose of getting used to its configuration and operating. Keep the manual for any after-query.

www.fanox.com

DIMENSIONS / CUTOUT

Unit: mm

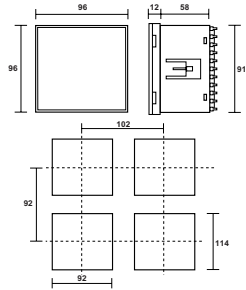

WARNING

- » Make sure to tight correctly the connection terminals. If this is not done correctly mechanical failures or even fire may occur.
- » Please, do not install this equipment in locations where inflammable gases can exist, due to the possibility of explosion.
- » The life-time of the equipment depends on the way of use. If that life-time is exceeded, the probability of deterioration of the equipment increases.
- » Do not dismatle, review or repair the equipment by your own without authorization. This can cause short circuits on electrical parts, failures or fire.
- » Do not introduce metallic elements between the chips of the interior of the equipment or short circuits and fire could be produced.

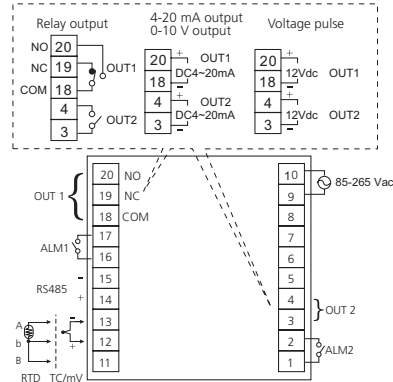

CAUTION

Please read the following warnings carefully, which will allow you to use correctly the equipment:

- » Use the equipment within the specified limits for its water immersion and exposure to oil.
- » Do not use the equipment in locations exposed to vibrations or thumps. The use of the equipment in these locations can cause damages due to stress.
- » Do not use the equipment in locations exposed to dust, corrosive gases or direct sun.
- » Separate the input signal devices, the cables of input signal and the equipment from noise sources or high voltage cables that generate noises.
- » Separate the equipment from static electricity sources when the equipment is used in areas where a lot of static electricity is generated (e. g. manufacture of compounds, dusts or transport of fluid material by pipes).
- » The organic solutions as well as basic or acid solutions could damage the case of the temperature controller.
- » Store it to the specified temperature. If the temperature controller has been stored under - 10 °C, keep the equipment to room temperature during a minimum of 3 hours before using it.

Please, verify the supply characteristics of the equipment. Do not connect the terminals that are not going to be used.

We propose the use of AWG 18 – 24 cables for the signal line and AWG 25 – 30 cable for the supply and exit contact relay.

SPECIFICATIONS

- Supply:** 85–265 Vac, 50/60 Hz
- Display:** Upper display (red): 4 digits 0,56" 7 segments
Lower display (green): 4 digits 0,36" 7 segments
- Input signal:** Thermocouple: J, K, B, N, R, S, T, E
RTD: PT100, JPT100
Voltage DC: 0–350 mV
Output relay (resistive) SPDT, 5A/250 Vac
Output pulse voltage (SSR) NPN, 20 mA at 12 Vdc
Analog output (max. 600...): 4–20 mA, 0–10 Vdc
SPST-NO, 3A/250 Vac (resis.)
- Output control:** 00–999 s
0–3 digits
- Alarm relay:** 1–100 ON/OFF or PID (Autotuning)
- Dwell time:** -199,9–999,9
- Hysteresis:** 0000–9999
- Operating conditions:** 0–50 °C (20–85 % HR)
- Output control cycle:** 00–999,9 s
- Decimal point:** 0–3 digits
- Digital filter:** 1–100
- Control method:** ON/OFF or PID (Autotuning)
- Offset input:** -199,9–999,9
- Fraction value:** 0000–9999
- Setting range:** -19999–99999
- Accuracy:** ± 0,3 % ± 1 digit
- Sampling time:** 200 ms
- Memory:** EEPROM

FRONTAL PANEL

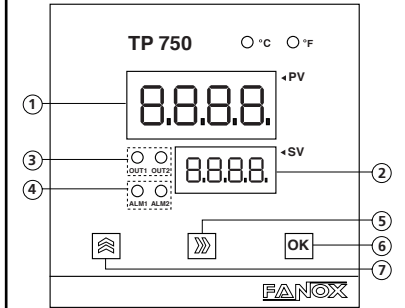

- 1 Process value and fuction visualization: Red LED of 7 segments.
- 2 Setting value and parameters visualization: Green LED of 7 segments.
- 3 Indication of the ouput control.
- 4 Indication of alarms.
- 5 key: [Forward] Advance to an inferior level and position.
- 6 key: [OK] Move in a level and confirm.
- 7 key: [Backward] Back up to a superior level and add.

PROGRAM SETTING FLOWCHART

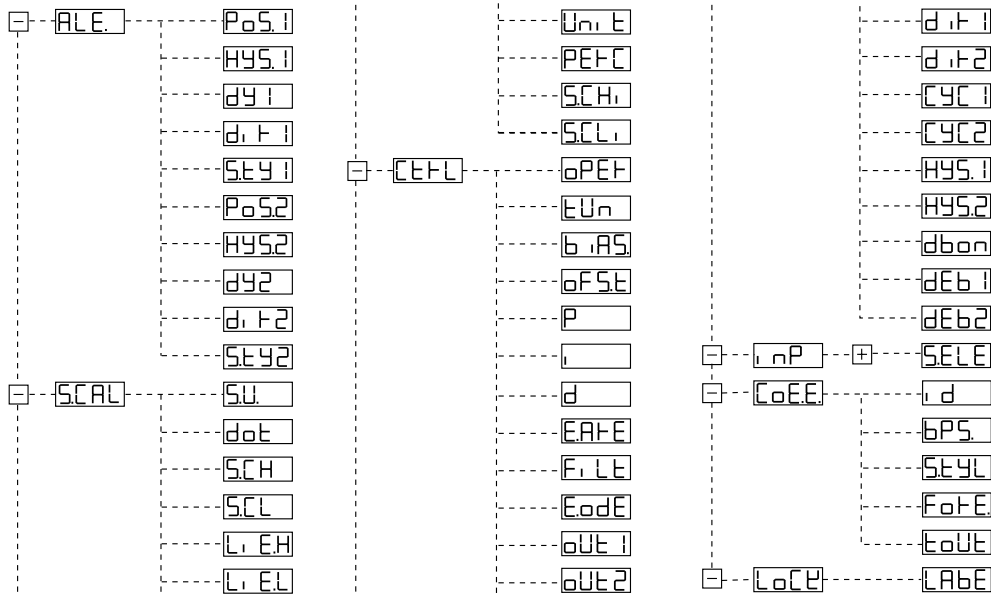

BUTTONS EXPLANATION

The settings of the equipment are controlled by means of 3 push-buttons located in the front. First you must decide to which function you want to enter and then use the push-buttons to reach it. The push-buttons are used in the following way:

	Selection	Settings
[Forward]	Advance to inferior level	Position
[Backward]	Back up to a superior level	Add
[OK]	Move in a level	Confirm

[OK] BUTTON "OK"

- 1) Allows to move in a menu.
- 2) Confirm to save the settings.

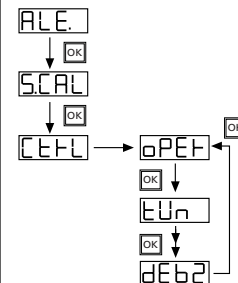

[Forward] BUTTON "FORWARD"

Allows to advance from a superior level to an inferior level.

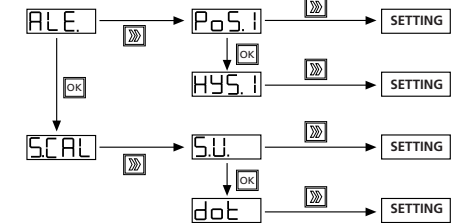

It is also used to move between the positions of the digits of a value to change.

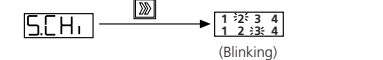

[Backward] BUTTON "BACKWARD"

Allows to back up from an inferior level to a superior one:

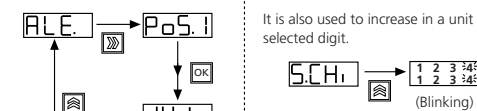

FUNCTION LIST

Item	Subitem	Range	Default	Description
AL E.	Po51	-1999-9999	0	Alarm relay position 1
	H451	0000-9999	0	Alarm relay hysteresis 1
	dY1	00-99	00 s	Alarm relay delay 1
	d.F1	H/L o	H.	Alarm relay direction 1
	SEY1	SE 1-SE8	SE1	Alarm relay style 1
		SE9		Alarm follow the action of Out 1
		SE10		Alarm follow the action of Out 2
	Po52	-1999-9999	0	Alarm relay position 2
	H452	0000-9999	0	Alarm relay hysteresis 2
	dY2	00-99	00 s	Alarm relay delay 2
d.F2	H/L o	H.	Alarm relay direction 2	
SEY2	SE 1-SE8	SE1	Alarm relay style 2	
	SE9		Alarm follow the action of Out 1	
	SE10		Alarm follow the action of Out 2	
SCAL	SU	-1999-9999	0	Set value SV
	dot	dot0-dot3	dot1	Decimal point set
	SCH	-1999-9999	9999	Scale upper limit value
	SL	-1999-9999	0	Scale lower limit value
	LiEH	-1998-9999	9999	Maximum range value SV
	LiEL	-1999-9998	-1999	Minimum range value SV
	Un.E	oC/oF	oC	Unit
	PEFC	on/off	OFF	Percentage
	SCHi	000,0-100,0	100	Scale input upper limit value
	SLi	000,0-100,0	0	Scale input lower limit value
CETL	oPEF	Pi d/oF	ON/OFF	Operation
	tUo	tUn/oFF	OFF	Autotuning
	biRS	-1999-9999	0	Input setting PV
	oFSE	-1999-9999	0	SV offset value during autotuning
	P	0000-9999	3	P value
	i	0000-9999	200	I value
	d	0000-9999	20	D value
	EARF	0000-9999	0	Manual reset
	F.Lt	1-100	1	Input digital filter
	EodE	H-C	H-C	Hold temperature over room temperature
oUt1	CoOL			Hold temperature below room temperature
	HEAT	HEAT		Heater is controlled by Out 1
	CoOL			Cooler is controlled by Out 1
	HEAT	HEAT		Heater is controlled by Out 2
oUt2	CoOL			Cooler is controlled by Out 2
	HEAT	HEAT		
	CoOL			
	HEAT	HEAT		

Item	Subitem	Range	Default	Description
CETL	d.F1	H/L o	H.	Control output direct / reverse operation 1
	d.F2	H/L o	H.	Control output direct / reverse operation 2
	CYC1	0000-9999	5 s	Cycle time 1 (seconds)
	CYC2	0000-9999	5 s	Cycle time 2 (seconds)
	H451	0000-9999	0000	Control output hysteresis 1
	H452	0000-9999	0000	Control output hysteresis 2
	dbon	on/off	OFF	Deadband control
	dEb1	-1999-9999	0	Deadband parameter of heater
	dEb2	-1999-9999	0	Deadband parameter of cooler
	SELE	J EP	J EP	Thermocouple type K (-200~1370 °C)
i nP	J EP			Thermocouple type J (-210~1200 °C)
	E EP			Thermocouple type T (-200~400 °C)
	E EP			Thermocouple type E (-200~1000 °C)
	F EP			Thermocouple type R (-50~1760 °C)
	S EP			Thermocouple type S (-50~1760 °C)
	B EP			Thermocouple type B (250~1820 °C)
	n EP			Thermocouple type N (-200~1300 °C)
	PEEP			Pt100 (-200~850 °C)
	JPEP			JPT100 (-200~850 °C)
	DC EP			DC Type (0~350 mV)
CoEE	i d	0000-0255	0001	Device ID number
	bPS	600	9600	BaudRate : 600
		1200		BaudRate : 1200
		2400		BaudRate : 2400
		4800		BaudRate : 4800
		9600		BaudRate : 9600
	SEYL	192-		BaudRate : 19200
		384-		BaudRate : 38400
		8n1	8n1	8 byte size; no parity; 1 stop bit
		8n2	8n2	8 byte size; no parity; 2 stop bit
8o1		8o1	8 byte size; odd parity; 1 stop bit	
FoFE	8e1	8e1	8 byte size; even parity; 1 stop bit	
	HEH	HEH	Hex	
	ASC	ASC	Ascii	
	0100-9999	0100	Time Out / ms	
	LoL	LbE	Lb00	Lock label 0
LoL		Lb01	Lock label 1	
		Lb02	Lock label 2	
		Lb03	Lock label 3	

DESCRIPCION PARAMETROS

- HYS.** Control output hysteresis
A hysteresis can be adjusted around the set point to prevent chattering.
- EARF** Manual reset
In PID control, I=0, PV=SV, reset the control output to the fixed value in this section.
- FILT** PV input filter
This function should be used when the value of PV fluctuates widely, due to noises in the input signal. If a longer constant time is fixed, the filter eliminate more noises.
- CYCL** Control output cycle time
The cycle time is the period of ON/OFF repetitions of a relay or voltage pulse output in the proportional PID control. The ratio of the ON time to the cycle time is proportional to the control output value.
- d.F** Direction of relay.
- LoCP** Function list lock
You can set the mode of function lists which can be displayed and edited.

TROUBLESHOOTING

- 1** Display over scale
- 4** Display under scale
- 0000** PV over scale
- UUUU** PV under scale
- Sensor break

ALARM MODE SETTING

▲: SV △: Alarm setting value ▼: Hysteresis setting value

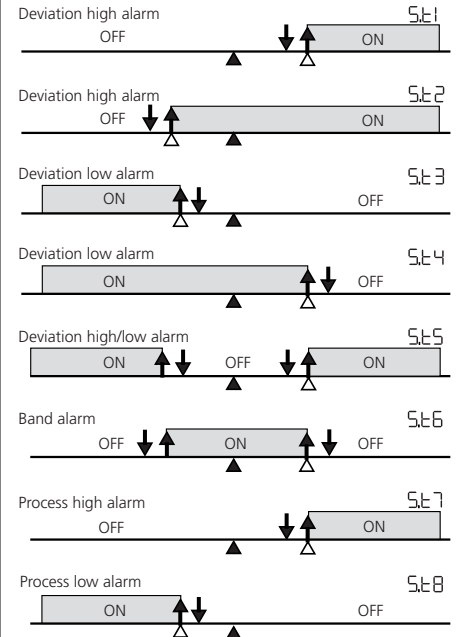

FUNCTION LOCK

LOCK	Lb03	Lb02	Lb01	Lb00
AL E.				
Po51			0	0
H451				0
dY1				0
d.F1				0
SEY1				0
Po52		0		0
H452				0
dY2				0
d.F2				0
SEY2				0
SCAL				
SU		0	0	0
dot				0
SCH				0
SL				0
LiEH				0
LiEL				0
Un.E				0
PEFC				0
SCHi				0
SLi				0
CETL				
oPEF			0	0

LOCK	Lb03	Lb02	Lb01	Lb00
tUn			0	0
biRS			0	0
oFSE			0	0
P			0	0
i			0	0
d			0	0
EARF			0	0
F.Lt			0	0
EodE			0	0
oUt1			0	0
oUt2			0	0
d.F1			0	0
d.F2			0	0
CYC1			0	0
CYC2			0	0
H451			0	0
H452			0	0
dbon			0	0
dEb1			0	0
dEb2			0	0
i nP				
J EP				0
E EP				0
E EP				0

LOCK	Lb03	Lb02	Lb01	Lb00
E EP				0
F EP				0
S EP				0
B EP				0
n EP				0
PEEP				0
JPEP				0
DC EP				0
CoEE				0
i d				0
bPS				0
SEYL				0
FoFE				0
tOUt				0
LoL				0
LbE	0	0	0	0

FANOX ELECTRONIC
 PAE. Asuaran, Edif. Artxanda, 23
 48950 ERANDIO (Bizkaia) - SPAIN
 Tel: +34 94 471 14 09 ; Fax: +34 94 471 05 92
 www.fanox.com

HYSTERESIS

	Cal.	Enf.
SV+dEb2	X	0
SV	X	X
SV+dEb1	X	X
	0	X

dEb1 < 0 ; dEb2 > 0

	Cal.	Enf.
SV+dEb2	X	0
SV	0	0
SV+dEb1	0	0
	0	X

dEb1 > 0 ; dEb2 < 0

X: (Disable): Inhibit output.
 O: (Enable): Enable control output to follow PID / ON-OFF control algorithm