

EMM-5 ELECTRICAL MULTIFUNCTION METER

GENERALITY

These digital multimeters series allow to monitor all the electrical parameters present on a distribution line. The local display of 30 electrical parameters is carried out by 4 display with red LED guaranteeing a good and contemporary reading of more measures. A simple front panel completes the intuitive selection of several electrical parameters, with a great quantity of information.

These instruments, over of the instantaneous measures, display the maximum peak of the main parameters (maximum peak and maximum demand).

The presence of the serial port communication EIA485 (option) allows the connection in network of more instruments to realize centralized measure networks.

These multimeters replace in a unique device, all the functions of voltmeters, ammeters, energy meters, cosphimeters, wattmeters, varmeters, frequency meters permitting a great economic saving, a reduction of dimension and the wiring energy and a simplification in the purchase and management of the instruments because this is a model usable at all of need of local measure in the electrical panel, machine, etc.



OPTIONS

- internal CT
- digital output (in alternative to the serial port)
- serial port (in alternative to the digital output)
- power supply different from standard version
- current input 1A

MEASURED PARAMETERS

parameters	unit of measurement	initial identification			
phase and three phase voltages	[V-kV]	V _{L1-N}	V _{L2-N}	V _{L3-N}	Σ V _{L-N}
phase to phase and three phase system voltages	[V-kV]	V _{L1-L2}	V _{L2-L3}	V _{L3-L1}	Σ V _{L-L}
phase and three phase currents	[A-kA]	A _{L1}	A _{L2}	A _{L3}	Σ A
phase and three phase power factors		PF _{L1}	PF _{L2}	PF _{L3}	Σ PF
phase and three phase active powers	[W-kW-MW]	W _{L1}	W _{L2}	W _{L3}	Σ W
phase and three phase system reactive powers	[VAr-kVAr-MVAr]	VAr _{L1}	VAr _{L2}	VAr _{L3}	Σ VAr
phase and three-phase system apparent powers	[VA-kVA-MVA]	VA _{L1}	VA _{L2}	VA _{L3}	Σ VA
frequency	[Hz]	Hz _{L3}			
temperature	[°C]	T			
three phase system active energy	[kWh]	Σ kWh			
three phase system reactive energy	[kVArh]	Σ kVArh			
three phase system apparent energy	[kVAh]	Σ kVAh			
hours counter	[hr]	h			
peak value (maximums):					
maximum phase voltages	[V-kV]	V _{L1-N max}	V _{L2-N max}	V _{L3-N max}	
maximum phase currents	[A-kA]	A _{L1 max}	A _{L2 max}	A _{L3 max}	
maximum three-phase powers	[W-VAr-VA (k-M)]	Σ W _{max}	Σ VAr _{max}	Σ VA _{max}	
maximum average phase currents (maximum demand)	[A-kA]	I _{L1 max (avg)}	I _{L2 max (avg)}	I _{L3 max (avg)}	
maximum average three-phase powers (maximum demand)	[W-VAr-VA (k-M)]	Σ W _{max (avg)}	Σ VAr _{max (avg)}	Σ VA _{max (avg)}	
average phase currents	[A-kA]	A _{L1 avg}	A _{L2 avg}	A _{L3 avg}	
average three-phase powers	[W-VAr-VA (k-M)]	Σ W _{avg}	Σ VAr _{avg}	Σ VA _{avg}	

INSTALLATION

WARNING FOR THE USER

Read carefully the instructions/indications contained in this manual before installing and using the instrument.

The instrument described in this manual is intended for use by properly trained staff only.

SAFETY

This instrument has been manufactured and tested in compliance with EN 61010-1 standards. In order to maintain these conditions and to ensure safe operation, the person must comply with the indications and markings contained in the manual. When the instrument is received, before beginning installation, check that it's O.K. And it has not suffered any damage during transport. When starting installation make sure that the operating voltage and mains voltage are compatible with the device instructions. The instrument power supply must not be earthed. Maintenance and/or repair must be carried out only by qualified and authorized personnel. If there is ever the suspicious that, that there is a lack of safety ,during operation, the instrument must be disconnected and cautions taken against accidental use.

Operation is no longer safe when: - The instrument doesn't work. / - The measured value are obviously wrong or unreasonable / - There is clearly visible damage. / - After serious damage incurred during transport. / - After a storage under unfavourable conditions

CONNECTION

For a correct use of the device, the wiring diagram contained in the present manual, must be respected.

The connections are available on the screw terminal:

- auxiliary power supply:

The power supply is take from voltage inputs.

Are available 3 different auxiliary supply:

0 - 115V = 100-130V 50-60Hz	(N-L3)	(on request)
0 - 230V = 220-240V 50-60Hz	(N-L3)	(on request)
0 - 400V = 380-415V 50-60Hz	(L2-L3)	(standard model)

It's possible, for example, to give an auxiliary power supply between phase and neutral, in a 4 wires system, or phase-phase in a 3 wires system, without neutral or from a VT in a medium voltage application.

In the standard version the voltage is 400V and it's taken between the phases L2-L3.

In the following table it's possible to see the measurable voltage depending of the type of power supply.

power supply terminals	rated voltage	range of measurable voltage
L2-L3 (phase to phase power supply)	400V	300÷500V phase to phase (175÷290V phase-neutral)
	230V	175÷290V phase to phase (130÷170V phase-neutral)
	110V	85÷145V phase to phase (50÷85V phase-neutral)
L3-N (phase – neutral power supply)	230V	300÷500V phase to phase (175÷290V phase-neutral)
	110V	175÷290V phase to phase (100÷170V phase-neutral)

The standard version allows to apply the instrument at all the three-phase network 400V with or without neutral supplied. For example for application on single phase 230V will need the L3-N / 230V. while for applications in medium voltage (for example using external voltage transformer 15 / 0.1 kV phase to phase) will need the version L2-L3 / 110V.

- measure voltage inputs:

4 terminals are available for the connection to the 3 phase and neutral of the network of measure, the maximum voltage phase to phase shouldn't be over 500 V rms and dependent to the auxiliary power supply. In case of a 3 phase system without neutral, or non distributed neutral to leave terminal N free. It's possible to use external voltage transformer in fact the transformation rate of the external transducer can be set in the SETUP of the instrument and the visualization allows the reading of voltage up to 40,0 kV.

- measure current inputs:

4 terminals are available for the connection to 3 external amperometric transformers with secondary 5A, it's possible to use 2 TA on lines with 3 wires (insertion three phase Aron). The utilization of external TA is obligatory. The transformation rate of the external transducer can be set in the SETUP of the instrument and the visualization allows the reading of voltage up to 9,99 kA.

REMARKS: It's a must to respect the phase sequence. The connections between current and voltage phase inputs must not be inverted (for example, CT placed on phase L1 must correspond to the I1 input). So as it is not correct to invert S1 and S2 terminals, since power factors and powers might not be reliable. For fixing the flush mount version instrument to the panel, use the fixing devices supplied, by inserting them in the side grooves of the enclosure and tighten the screws.

For safety reasons, place an external fuse protection at the input voltages, and use adequate cables for the working voltages and currents, with a cross sections from 0,5 to 2,5 mm².

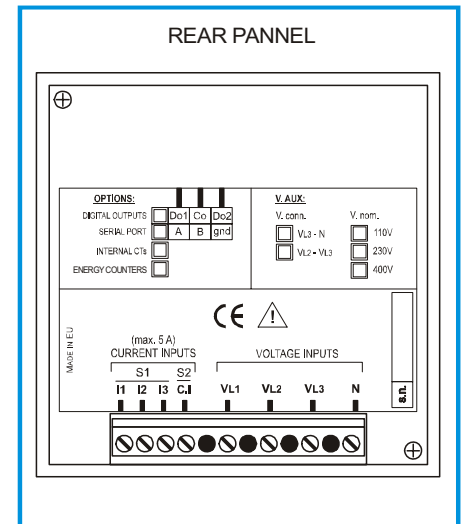

WIRING DIAGRAMS

INSERTION ON THREE PHASE LINE WITH 3 OR 4 WIRES

on line with 3 wires (without neutral or with neutral not supplied) the N terminal must not be connected

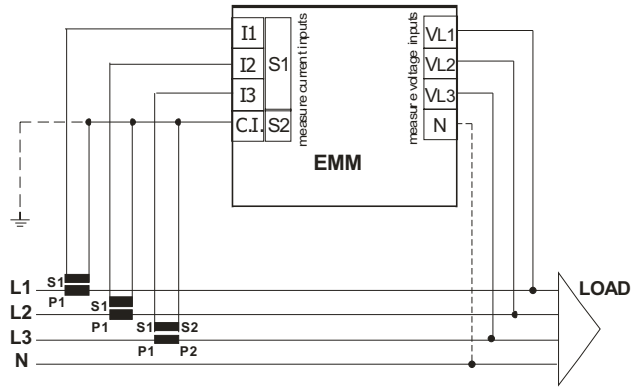

INSERTION ON THREE PHASE LINE WITH 3 WIRES AND 2 CT (insertion AARON)

*the voltage insertion with 2 VT is possible only for the version with internal TA

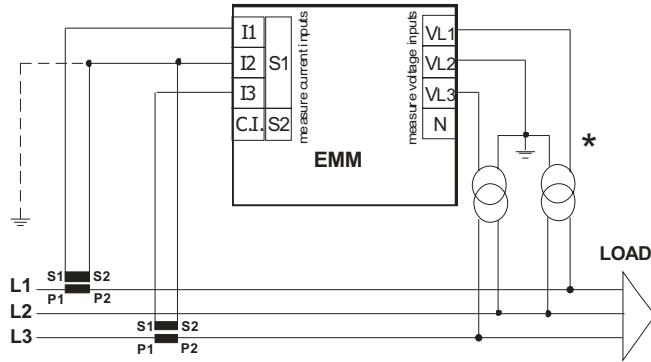

INSERTION ON THREE PHASE LINE WITH 4 WIRES AND 3 VT

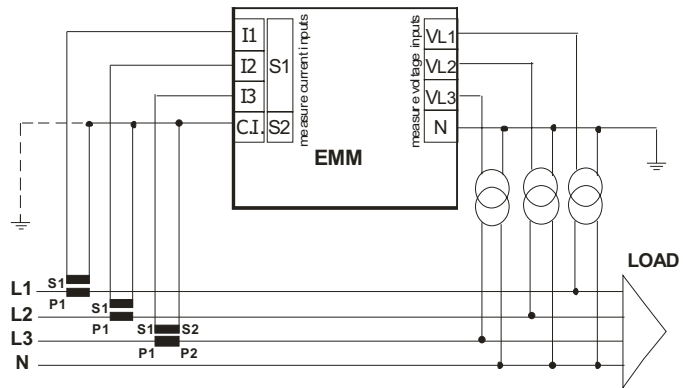

INSERTION ON SINGLE PHASE LINE

if the multimeters are used on single phase line, the measure are referred at the L3 phase. The others data displayed relatives at value of three phase system are not to consider.

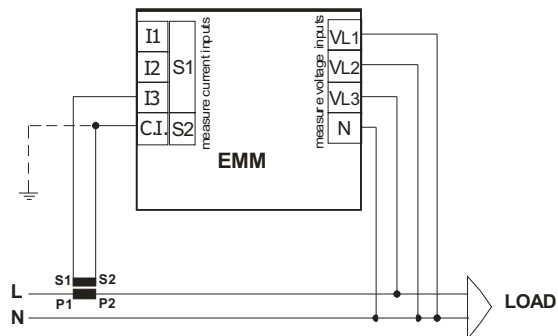

NOTE:
in the instrument version with digital outputs programmed like "pulse"
output DO1 for ACTIVE ENERGY pulses
output DO2 for REACTIVE ENERGY pulses

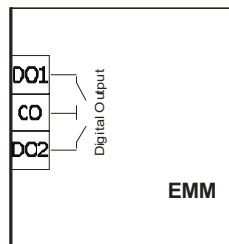

Max 150mA
Max 230Vac/dc

DESCRIPTION FRONT PANEL– OPERATORS

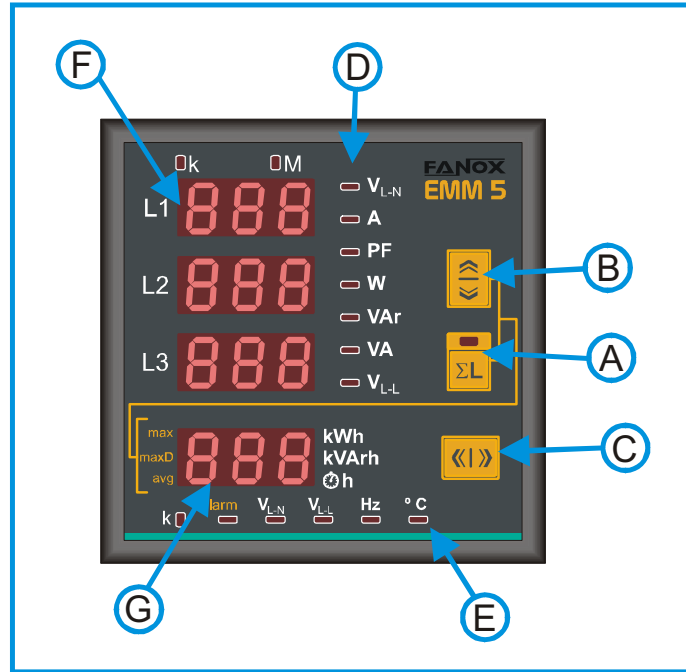

LEGEND:

- A:** push-button for the visualization of electrical parameters of three-phase system with the corresponding LED indication. In modality programming (SETUP) it's used to confirm the parameter set.
- B:** push-button for the selection of the electrical parameter to be displayed on display **F**. In modality programming (SETUP) it's used to increase the value of the parameters to set.
- C:** push-button for the selection of the electrical parameter to be displayed on display **G**. In modality programming (SETUP) it's used to reduce the value of the parameters to set.
- D:** LED bar for the indication of the electrical parameter displayed on display **F**.
- E:** LED bar for the indication of the electrical parameter displayed on display **G**.
- F:** 3 displays for the visualization of electrical measures of every phase.
When ΣL LED is ON, only the main display will be active showing the three-phase system value of the electrical measure selected.
LED **k** and **M** show the eventual multiplying factor (k = kilo=x 1.000, M =Mega= x 1.000.000)
If it's selected with the **C** key the display indicates also the values of the active, reactive and apparent energy counters. If it's selected with the **A** and **B** keys the display indicates the maximum and average values.
- G:** display for the visualization of the electrical measure indicated in LED **E** (energy counters excluded).
The voltage values are referred to the three-phase system.
The **k** LED displays the reading in kilo (x 1000).
If it's selected with **C** key the display indicates the type of the energy displayed. If it's selected with **A** and **B** keys, the display indicates the type of average of maximum values.
- A+C:** when pressing simultaneously the instrument pass to the following menu:
- instrument programming (SETUP)
 - energy counters and peak values deleting (RESET)
 - digital outputs programming (SET DO1; SET DO 2) (only for version with digital output)
 - hour counter programming (HR_)
 - I/O diagnostic page

A+B: when pressing simultaneously the instrument pass to the visualization of average and maximum values stored.







































































MENU OF INSTRUMENT PROGRAMMING (SETUP)

To enter in SETUP it's necessary to press at the same time **A** and **C** keys, on the **F** display will appear the message SETUP. Pressing the **A** key on the **G** display will appear the message SET that will remain always displayed during the set of each parameter to highlight the SeTUp phase in running.

The set values will be keep also in absence of auxiliary power supply.

SET GENERAL PARAMETER (SET UP)

Entry to menu:
set UP →

	Entry to menu: set UP →			
			seT Up RESET SET DO1 SET DO2 SET HR_ DO_ OFF OFF	
			SET CT Set CT ratio from 1 to 2000	  Increase  Decrease
			SET VT Set VT ratio from 0.1 to 400.0	  Increase  Decrease
			seT AV9 T Set average time from 1 to 30 minutes	  Increase  Decrease
			seT EN Set Energy visualization type	  TOT PAR NORMAL 
			seT 3pH Set connection Type	  BALANC  UN_BAL
			seT MDE Set wiring connection type	  -3-  -4-
			seT SYN MDE Set synchronism type	  L3 50  60
			seT PUL SE Set pulse weight (version with digital output)	  10.0 kW-kVAr / pulse 01.0 kW-kVAr / pulse  0.10 kW-kVAr / pulse 0.01 kW-kVAr / pulse
			seT TPL from 100 to 500 mS in step by 100 mS (version with digital output)	  Increase  Decrease
			seT ID ADR Set address of network from 001 to 127 (version with serial output)	  Increase  Decrease
	Set baud rate serial interface (version with serial output)		seT SER BDR 19200 baud 9600 baud 4800 baud 2400 baud	  19.2 9.60  4.80 2.40
	Set parameters of Communication serial interface (version with serial output)		seT PAR bit: 8data 1stop-no parity bit: 8data 2stop-no parity bit: 8data 1stop-even parity bit: 8data 1stop-odd parity	  8.1 pAR NO 8.2 paR NO  8.1 paR eVe 8.1 paR ODD
			SET PAS Set Password OFF - 0002 ÷ 9999	  Increase  Decrease
			Confirm and end of general settings	

Programming of the transformation ratio of the external current transformers (SET CT)

The programming of the CT ratio, intended as the ratio between the primary and the secondary circuit (example: with CT 1000/5 it must be set 200), has to be performed by using the front keys.

After the enter in the setup (message **SETUP** on **F** display) pressing the **C** key, the message **seT** will appear on the **G** display and the message **CT** (Current transformer ratio) on the first **F** display; the transformation ratio value (set to 1 by the manufacturer) on the second and the third **F** display. Press **B** or **C** keys to increase or decrease the value respectively (the variation is performed unit by unit). In order to speed up the operation, keep the **B** or **C** key pressed, the variation will be performed by tens and hundreds. To increase or decrease the value by unit, it is necessary to release and to press the button again. To confirm the set value, press the **A** button; in this way it is possible to enter the next programming. If none key is pressed for 10 seconds, the instrument will automatically leave the programming menu and the eventual setting SHALL NOT be stored.

- Programming of the transformation ratio of the external voltage transformers (SET VT)

After the precedent programming phase, on **F** display will appear the inscription **Vt** (voltage transformer) and the value of the transformation rate of the external TV (set to 1 from the constructor), considered as the rate between primary and secondary (example with TV 15/0.1 kV the value will be 150). In the same way at the programming of the CT rate will be possible to set this value. If the external TV are not used the value to set will be 1. To confirm the value press the **A** button.

If the instrument has not options the programming continues with the set of average time **AVG T'** and after with the password **PASS**, then it come back at the first page **SETUP**. The presence or the absence of the options, neutral current, digital output and serial output, will allow the visualization or not of the other settings.

Programming of the average time (seT AVG T')

After the programming phase previously described, pressing another time the **A** key, on the **F** display will appear the message **AVG T'** and the average time settable from 1 to 30 minutes.

To increase the value press the **B** key. To decrease it, press the **C** key. To confirm it press the **A** key.

The average time is the time used to calculate the average parameters (**avg**) and the maximum demand (**maxD**).

Programming of the energy visualization type (seT EN)

This setting allows to define the energy visualization type after the visualization of the temperature.

With **TOT PAR** will have the visualization of the partial and total energy counters. With **NORMAL** there will be only the visualization of total counters (that it's possible to reset from **RESET** menu).

Programming insertion mode (3PH)

In a unbalance three phase system it's necessary to set **UN_BAL** (unbalance) while in a balance system (only one CT and only one VT) the correct set is **BALANC** (balance).

Programming wiring connection mode (MDE)

This setting allows to definite the wiring type connection. It's possible to chose 3 wires or 4 wires. With the 4 wires connection the neutral parameter are displayed and enabled to use for the digital and analog outputs settings.

Programming of the synchronism type (SYN MDE)

In this setting for the synchronization type, it's possible to choose L3 to use the external frequency (on L3 phase) or 50, 60 Hz to use the internal clock.

Programming of the weight of the active and reactive energy pulse (seT PULSE) (only for vers. with digital output)

After the above mentioned programming, by pressing the **A** key again, the message **Pul se** will appear on the **F** display and the value of the weight of one pulse settable on three phase values: **0,01 - 0,1 - 1 - 10 kWh** or **kVArh** (for each emitted pulse the instrument will have counted **0,01 - 0,1 - 1 - 10 kWh** o **kVArh**).

Press the **B** key to increase the value or **C** key to decrease the value and **A** to confirm.

Programming of the duration pulse (SET TPL) (only for vers. with digital output)

The message **TPL** will appear together the value of the duration pulse expressed in mS. It's possible to select the value from 100 mS to 500 mS, with 100 ms steps by using **B** key (to increase the value) and **C** (to decrease the value). Confirm the value pressing the **A** key.

This setting is used by all digital outputs.

Programming of the address for the communication network (SET ID ADR) (only for vers. with serial output)

After the confirm with the **A** key of the previous value, the message **ID aDR** will appear on **F** display; to set the value that will identify the instrument when it will be connected in a EIA485 communication network, proceed with the modality, already described. The settable values are from 1 to 247. To confirm, press the **A** key.

Programming of the baud rate (SET BDR) (only for vers. with serial output)

The following setting is the baud rate. The message SET appears on G display, the message SET BDR on the first two parts of F display to indicate the programming of the baud rate displayed on the third part (L3) of the F display. To modify the value set, it's necessary to use the C key to decrease and B to increase the rate. The values settable are:

- 19.2 => 19200 baud
- 9.60 => 9600 baud
- 4.80 => 4800 baud
- 2.40 => 2400 baud

Press A to confirm the value displayed.

Programming of the serial parameters (only for vers. with serial output)

On G display will appear the message SET. The following message will appear on F display using the B and C keys. To confirm press the A key.

8 1	8 data bit / 1 stop bit	8 2	8 data bit / 2 stop bit	8 1	8 data bit / 1 stop bit	8 1	8 data bit / 1 stop bit
PAR	No parity	PAR	No parity	PAR	Even parity	PAR	Odd parity
NO		NO		EVE		ODD	

Programming of the Password (SET PAS)

The instrument is supplied without password. When a password (from 0002 to 9999) is set, using the B (to increase), C (to decrease) and A (to confirm) keys, only who know this value can to enter in the setup. The password, in fact, is required all the time that someone try to enter in the setup (pressing the A and B key at the same time). If the password is wrong, the message PASS ERR will appear on F display and the instrument go back to the measures visualization. To input the password, when required by the instrument, at the enter of the setup, use the A, B and C keys as the same way done previously.

The menu is cyclic. After the last setting, the instrument go back to the first page of Setup (SETUP). It's always possible to come back to measures visualization mode pressing at the same time the A and C keys.

PEAK VALUES AND ENERGY COUNTERS RESET (RESET)

From the measures visualization mode, pressing the A and C keys simultaneously the message SETUP will appear on F display, press the key C until the message RESET appears on the same display. To accede to the menu, press the A key. Now it's possible to select the enabling of cancellation type, by pressing the C key, according with following types:

- RESET PEA: all maximum value will be delete.
- RESET AVG: all average and average maximum value (maximum demand) will be delete.
- RESET EN: with NORMAL as energy mode (EN) the total energy counters will be delete, with TOT PAR the partial energy counters will be delete.
- RESET ALL: to delete all average and maximum values and all energy hours counters.

Entry to menu:

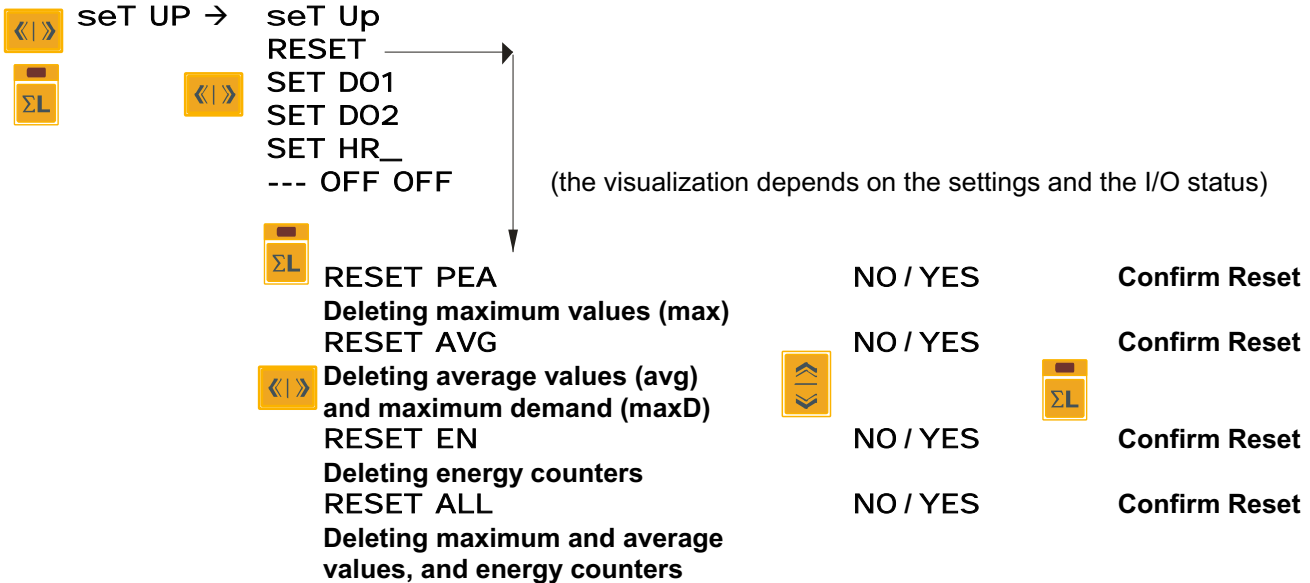

To enable the chosen type, press the B key to change the indication on display G from NO to yes. Confirm enabling cancellation, by pressing the A key. The indication on display G change from yes to --- .

PROGRAMMING OF THE DIGITAL OUTPUT (SET DO1 SET DO2) (only for vers. with digital output)

The DO1 and DO2 digital outputs have three modality of functioning: PULSE, alarm (ALR) and REMOTE command. The DO1 modality setting is independent from DO2. For example it's possible to set DO1 on PULSE (pulse emission) and DO2 on alarm mode (ALR).

In the menu SET DO1 and SET DO2 it's possible to program the function of all digital outputs. In these menus are available the following modality: PULSE, ALR and REMOTE.

In PULSE mode the digital output DO1 will emit pulses proportional to the active energy counted while the digital output DO2 will emit pulses proportional to the reactive energy counted. The proportionality will depend from the PULSE set in the SETUP and the duration of the impulse is set in the TPL voice of the SETUP.

The ALR modality is divided in two parts: ALR SYS 3PH and ALR SYS 123. With ALR SYS 3PH the digital output will function as alarm verifying that the three phase value doesn't exceed the threshold set (ALR HI and ALR LO). With ALR SYS 123 the digital output will function as alarm verifying that the maximum value of the single phases doesn't exceed the maximum threshold set (ALR HI) and that the minimum value of the single phases doesn't come down the minimum threshold set (ALR LO). The activation of the alarm output will come after some seconds of delay set (ALR DL).

In the REMOTE mode, the output status will be decided from the status of the correspondent MODBUS register (see protocol modbus manual for EMM).

Enter to menu:

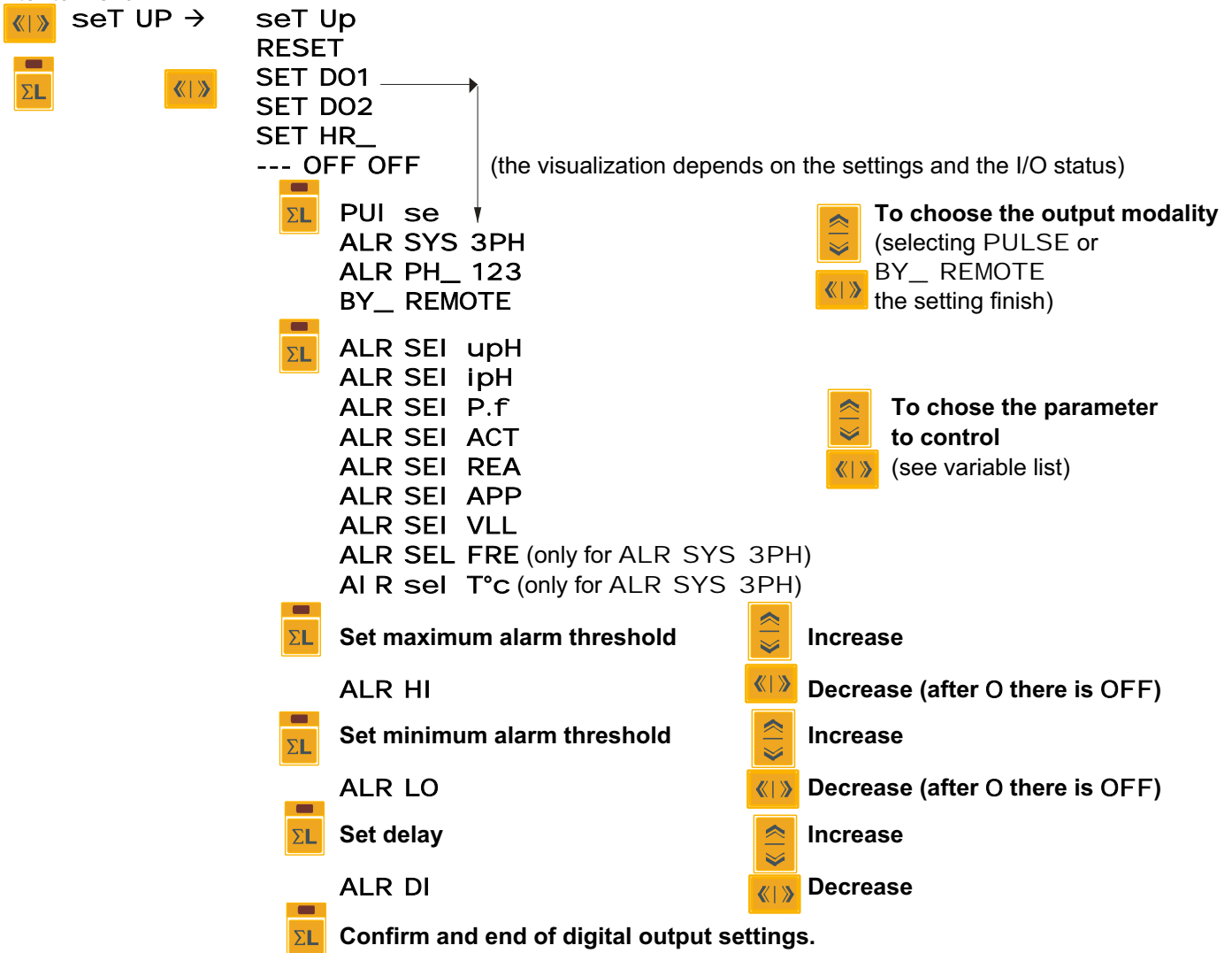

ENTER IN THE SETUP

From the measures visualization, press at the same time the **A** and **C** keys, the message **Set Up** will appear on the **F** displays.

CHOOSE THE DIGITAL OUTPUT TO PROGRAM

Press repeatedly the **C** key until the message **SET DO1** (DO1 output) or **SET DO2** (DO2 output) appears on the **F** display. Press the **A** key to select this setting.

SELECT THE MODALITY OF FUNCTIONING OF THE DIGITAL OUTPUT

To select the functioning mode, using the **B** and **C** keys, it's possible to select: **PULSE** (pulse emission), **ALR SYS 3PH**, (alarm on three phase value), **ALR PH_ 123** (alarm on minimum and maximum single phase value) and **BY_ REMOTE** (the digital output is managed using serial output). Press **A** key to confirm.

CHOOSE THE PARAMETER TO LINK TO THE DIGITAL OUTPUT

With an alarm modality set, it's necessary to select the parameters associated to the alarm output; by pressing the **B** and **C** keys until the parameter choice appears on the third part (L3) of **F** display and the glowing the corresponding led on the **D** bar. Press **A** key to confirm the set.

SET THE HIGH AND THE LOW THRESHOLDS

On **F** display will appear the message **ALR HI** with the high threshold value; confirming with the **A** key on the same display will appear the message **ALR LO** with low threshold value. The **B** (to increase) and **C** (to decrease) keys are used to set the high and the low thresholds values. The range depends by the parameter and it is linked to the CT and VT ratios. Pressing **A** key to confirm.

The threshold set is linked with CT and VT ratios, for this reason it's necessary to make this operation after the programming of the CT and VT. The end scale value must be confirmed when CT and VT ratios are modified.

The low threshold will be lower than high threshold. If the high threshold is set as OFF the low threshold will have the range of the high threshold.

SET THE DELAY TO THE DIGITAL OUTPUT ACTIVATION

Now it's possible to set the delay that will pass between the alarm condition set and the activation of digital output. On **F** display will appear **ALR DLY** and the value expressed in seconds (range 1+900). The modification of the value is done in the same way of the threshold set. With the confirmation (**A** key) the set is complete.

The programming will be referred to the digital output indicated on **G** display (**DO1** o **DO2**).

PROGRAMMING OF THE HOURS COUNTER (SET HR_)

The hour counter will be increased when the measure of the parameter will exceed the set threshold value.

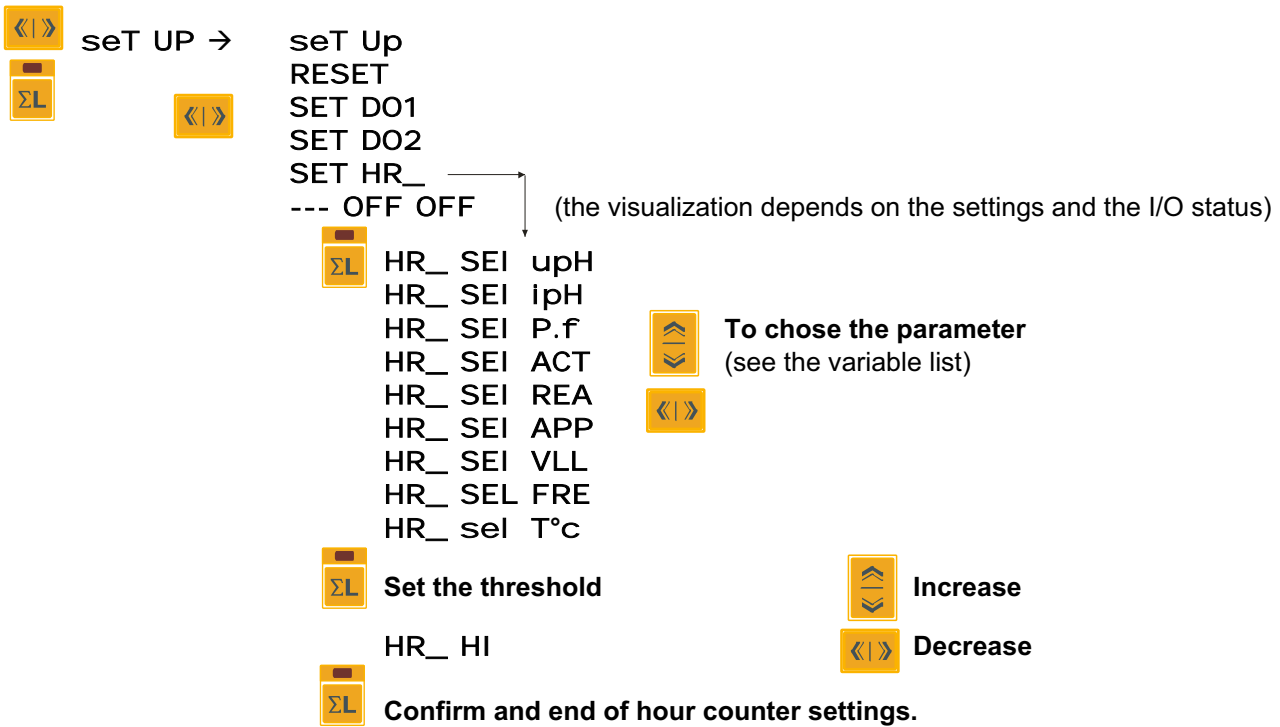

SELECT THE PARAMETER TO LINK TO THE HOURS COUNTER

From the previous setting, pressing the **C** key it's possible to set the hours counter: the message **SET HR_** appears on the **F** display. Press the **A** key to define the parameter to link to the hours counter. Press more time the **B** key to select the parameter and the **A** key to confirm it.

SET THE THRESHOLD

Subsequently it's necessary to set the threshold using the **B** (to increase) and **C** (to decrease) keys. Confirm with **A** key.

I/O INFO PAGE

After the hour counter set, the I/O info page appears in F displays: on the second part (L2) the status of the first digital output (DO1), on the third part (L3) the status of the second digital output (DO2).

The visualization of the status of the two digital outputs is **ON** if the digital output is activated or **OFF** if deactivated.

The status of the serial port appear on the **G** display when the instrument has this option. If the instrument receives data, it displays the letter R and the number of the instrument that is in communication while if the instrument transmits data, it displays the letter T.

VARIABLE LIST

VPH	three-phase voltage
IPH	three-phase current
P.F	three-phase power factor
ACT	active power
REA	reactive power
APP	apparent power
VLL	phase to phase voltage
FRE	frequency
T°C	temperature

MEASURES VISUALIZATION

The instrument is divided in two distinct sections:

the first is composed by three displays (F), by A and B keys and by LED bar D; the second (in the low part) is composed by G display, by C key and by LED bar E.

The two sections are to consider as two different instruments in a only one box, in fact it's possible to act in a zone without to modify the visualization in the other (peak value and energy counters visualization excluded).

Visualization section 1

The three measures of phases (on L1, L2 and L3), of the parameter indicated from the led D on, appears on F display. For the measure of the phase to phase voltages (V L-L), the three measures are V_{L1-L2} , V_{L2-L3} , V_{L3-L1} .

It's necessary to press the B button to select the parameter that can be displayed and indicated from D LED.

Press A button to see on F display the three phase value (the average of the single phase of voltage, current, power factor and the sum of single phase for the power) of the parameter selected: the led inside the A key is on.

To press another time the same key the visualization come back at the phase values.

The unit of measurement can be expressed in kilo or Mega, in the this case the relative LED is on.

A sign - on the first digit indicates the visualization of the capacitive power factor (example the reading -.95 indicates a power factor of 0.95 capacitive)

Visualization section 2

At the same way of the section 1, press the C button to select the parameter that can be displayed and indicated from E LED. The voltage values are of the three phase system, the frequency is of the L1 channel.

Visualization energy and hours counters

With the C key it's possible to visualize on F display the active, reactive and apparent energy counters. One segment of the right digit of the G display, in correspondence of the kWh and kVArh on the front panel, turn on, to indicate the visualization of the active and reactive energy counters. The led VA and the segment of the right digit of the G display, in correspondence of ...h on the front panel, turn on, to indicate the visualization of the apparent energy counter. To complete the visualization the led k over the F display could be on.

This is the visualization if NORMAL is the set in EN voice of the setup. Instead if the setting is TOT PAR on the F display will be visualized alternatively the partial and the total active, reactive and apparent energy counters; the first digit of the G display indicates the type of the counter: P for the partial (the user could be reset it) and T for the total (it's not possible to reset it).

The right digit of G display, in correspondence of the ...h, turn on, when the visualization of hours counters is active.

The reading of the counters use the 9 digits (maximum reading 99999999.9) of the F display: the measure is displayed in the way that the L1 display will indicate the first 3 digits, the display L2 the seconds 3 digits and the L3 display the last 3. For example if: L1=000, L2=028, L3=53.2 the reading is 2853.2 kWh.

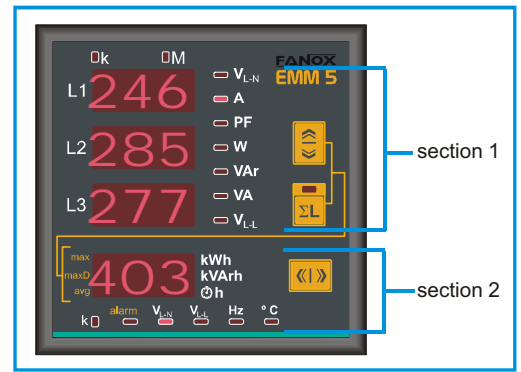

VISUALIZATION PEAK AND AVERAGE VALUES

Pressing at the same time the **A** and **B** keys, on **F** display will appear the average and maximum stored value, that are selected using the **B** key while a luminous segment on the **G** display indicates the type of the maximum and/or average value.

AVG: the average values are calculated on a average time set The calculation is at fixed window and it's synchronized when the instrument turn on.

The stored maximum values are the two types:

MAX: the instantaneous maximum values store the maximum value achieved by the parameter of measure for at least one second.

MAX AVG: the average maximum values (maximum demand) store the maximum value achieved in the average time as set in the setup menu.

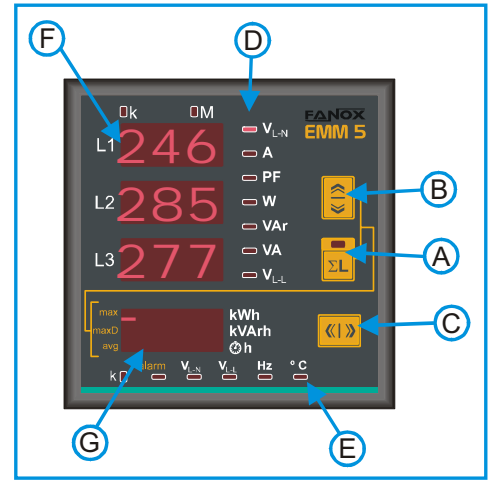

The integration for the calculating of the average values is synchronized all the time that the instrument turn on.

Press **A** and **B** keys another time to come back to the measures visualization. The instrument will come back to the measure visualization automatically if for 10 seconds no one button is pressed.

The average value, the maximum value and the maximum average value selectable with **B** key are the following:

parameter	Identifications / description	G display
phase voltages	$V_{L1-N \max}$ $V_{L2-N \max}$ $V_{L3-N \max}$	max -
	maximum instantaneous phase voltages	maxD -
phase currents	$I_{L1 \max}$ $I_{L2 \max}$ $I_{L3 \max}$	max -
	maximum instantaneous phase currents	maxD -
three-phase power	ΣW_{\max} ΣVAR_{\max} ΣVA_{\max}	max -
	maximum three phase powers (Σ)	maxD -
phase currents	$I_{L1 \max \text{ avg}}$ $I_{L2 \max \text{ avg}}$ $I_{L3 \max \text{ avg}}$	max -
	maximum of average phase currents (max. demand)	maxD -
three-phase power	$\Sigma W_{\max \text{ avg}}$ $\Sigma VAR_{\max \text{ avg}}$ $\Sigma VA_{\max \text{ avg}}$	max -
	maximum of average three phase powers (maximum demand)	maxD -
phase currents	$I_{L1 \text{ avg}}$ $I_{L2 \text{ avg}}$ $I_{L3 \text{ avg}}$	max -
	average phase currents	maxD -
three-phase power	ΣW_{avg} ΣVar_{avg} ΣVA_{avg}	max -
	average three phase powers	maxD -

NOTE relative to the measure

The refresh time of the display is lower of a second and it depends by the time of calculating of the measure and concerning the methodology of measure used in the way to allow a comfortable reading of value also in presence of fast variation of the measure parameter.

If the multimeters are used on single phase lines, the measures are referred at the phase L3. The other data displayed and relative to the three-phase system must not considered.

If the measure indicated by the instrument are not reliable or absurd it's necessary to verify the connection of the measure inputs of currents and voltages because must be respected the sequence of the phase, the corresponding of the currents and voltages of the same phase (the L1 voltage phase and the TA located on L1 phase must be connected on the L1 input) and the sense of the current (the S1 terminals of the TA must be connected at the S1 terminals of the instrument).

In some application where the secondary is connected to other instruments apart from the EMM multimeter, some problems could happen concerning the typology of the amperometric inputs.

If there are some problem call the assistance service.

COMMUNICATION INTERFACE EIA485 (RS485)

It is possible to exchange information between the instrument and a PC, PLC or other compatible system, through the asynchronous serial line RS485.

The interface EIA485 allows a multi-drop connection, in order to connect various instruments in the same network.

The maximum suggested length for a RS485 connection is 1200m.

For longer distances provide the use of low attenuation cables or signal amplifiers.

On the same RS485 it is possible to install up to 32 units, beyond this number of units it is required to place a signal repeater, each one of them will be able to manage up to 32 instruments.

The higher is the number of connected instruments on the same serial line, the lower will be their response speed.

Not shielded connection

As shown in the diagram, it is necessary to place a serial RS232/485 converter between the RS232 PC's outlet and the instrument/s.

it's necessary to insert a line termination resistance ($R_t=100\div 120\text{ ohm}$) between the twisted pair of cables, placing it between the converter and the end of the network (last instrument connected). Use always twisted cables with minimum section of $0,36\text{mm}^2$ (22AWG) and lower capacity of 60 pF/m (i.e.: BELDEN cable type EIA RS485-Ref.3105A).

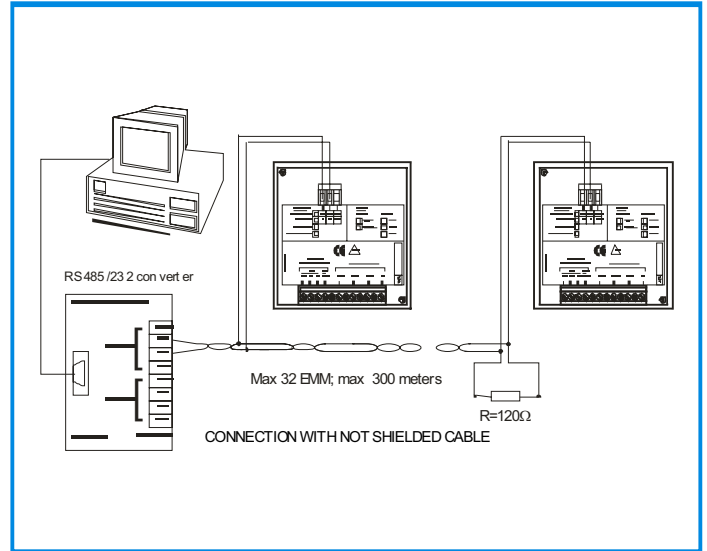

Shielded connection

Should it be the case of long distance networks, ambiances where there have been placed energy transporting cables or ambiances subject to be electrically disturbed, it is suggested to use $100\div 120\text{ohm } 1/2\text{W}$ resistors, placed between the common of the RS485 outlet and the shielded cable.

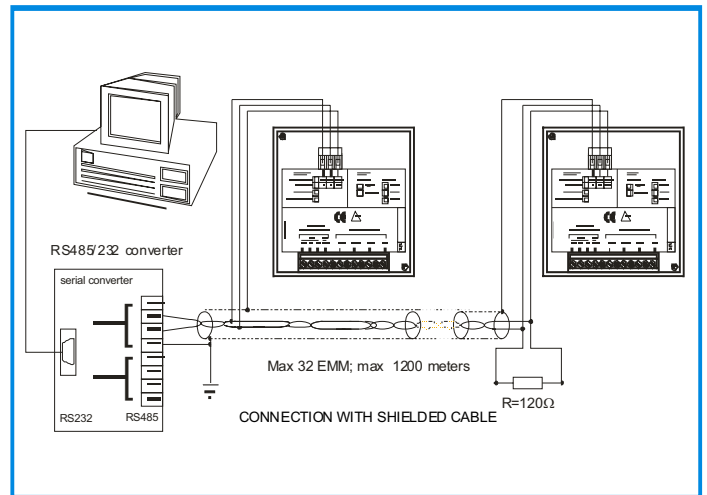

For other information on the serial line it's better to see the manual of EMI1 serial converter.

DIMENSIONS

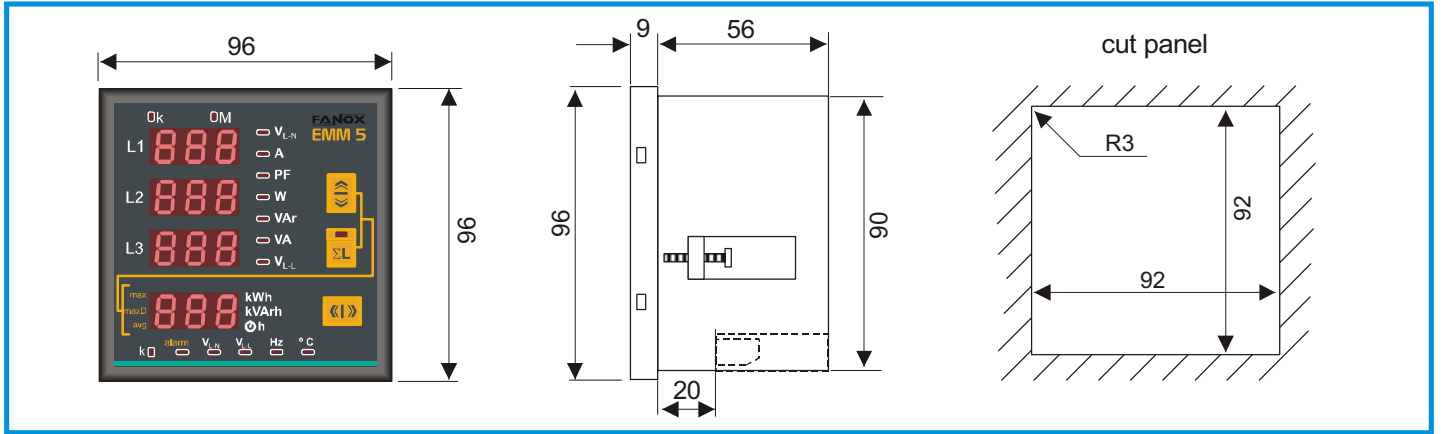

TECHNICAL FEATURES

MEASURES, PRECISIONS	
voltage	true RMS of the phase voltages and the phase to phase voltages and values of three phase system range of total measure: 20÷500V trms phase-phase - 290V rms phase-neutral dependent by the auxiliary power supply visualization (0,02÷50,0kV) - measure precision: ±0,5% ±1 digit- management maximum values
current	true RMS of the phase currents and of the value of three phase system range of measure: 0,02÷5A trms - measure precision: ±0,5% ±1 digit visualization 0,02÷9990A - management average and maximum values
frequency	frequency of the L3 phase -range of measure: 30÷500Hz precision: ±0,5% ±1 digit
powers	phase and three phase system reactive and active power range of measure: 0,001÷9990kW - 0,001÷9990kVA - 0,001÷9990kVA precision: ±1% ±1 digit - management average and maximum value
power factor	phase and three phase power factor range of measure: -0,1÷0,1 / precision: ±1% ±1 digit - management average and maximum value
energy measure	three phase system active, reactive and apparent energy range of measure: 0÷99999999,9 kWh / kVArh class 2 (IEC 1036) precision: ±1%
hours counter	precision: ±1%; resolution 1/10 of hour
AUXILIARY POWER SUPPLY, INPUTS	
auxiliary power supply	standard 380-415V ±15% - optional 100-125 / 220-240V ±15% frequency 50-60Hz - consumption 3VA voltage from the voltage measure input
voltage inputs	from 20 to 500V phase-phase (dependent from auxiliary power supply); permanent overload +20% - input impedance: 1 MΩ insertion on three phase line with 3 wires, 4 wires and single phase insertion in MT with external TV and transforming rate programmable from 0.1 to 400.0
current inputs	from 0,02 to 5A; permanent overload 30% - from external TA with secondary 5A, primary programmable from 5 to 10000A - auto-consumption <0,5VA
INPUTS / OUTPUTS	
digital outputs	Two outputs with common, optomos 12÷230Vac/dc, max 150mA, Insulation: 3kV for 60 second Pulse Function: Weight programmable 0,01-0,1-1-10 kWh/pulse Pulse duration 100-200-300 400 500 milliseconds selectable DO1: active energy pulse output DO2: reactive energy pulse output
serial output	One optional output RS485, baud rate selectable, MODBUS-RTU protocol Insulation: 3kV for 60 second
GENERALS	
display, operators	4 displays with red LED 10mm everyone of 3 digit by 7 segments 3 push-button for selecting measure and programming
mechanic	protection degree: IP52 frontal - IP20 enclosure and terminals - weight: about 0,5 kg connections with screw terminals for cable 2,5 mm ² enclosure thermoplastic self-extinguishing - flush mounting DIN 96x96mm, depth 56mm
environmental	working temperature: -10÷60°C; humidity <90% storing temperature: -25÷70°C insulation test: 3 kV for 1 minute
standards	CEI EN 50081-2; CEI EN 50082-1; CEI EN 61010-1



NOTE

At reason of the evolution of standards and products, the company reserves to modify in every time the features of the product described in this document, that it's necessary to verify preventively.

The liability of the producer for damage caused by defect of the product "can be reduced or deleted (...) when the damage is caused joint by a defect of product or for blame of the damaged or a person of which the damaged is responsible" (Article 8, 85/374/CEE).



Parque Tecnológico de Bizkaia, Edif. 604
48160 DERIO - BIZKAIA ESPAÑA
Tel. 0034 94 471 14 09 Fax 0034 94 471 05 92
E-mail: fanox@fanox.com Web: www.fanox.com