



VP series presents a complete and efficient range of transient overvoltage protection devices. A correct installation in several steps provides an adequate protection of the facilities, adapting the protection levels to the point where the SPDs are mounted (EN 61643-11, IEC 61643-1).

# VP C40 275/3

Class II (Type 2)

## ATTENTION

The mounting and connection of the device must be made by a qualified electrician. Please, read all the instructions carefully and follow the indications of the manual. In other case, an improper installation may result in serious damages of the electrical system or in installed equipments.

Disconnect the power of the line before installation. Never wire energized electrical components. Don't cut the cables until the SPD has been installed and the lengths of the cables have been verified.

Check that the SPD device doesn't have external damages. In case of finding damages or any other defect, don't proceed with the installation of the SPD. The use of this device is limited to the conditions mentioned and shown in this mounting manual. If charges are higher than indicated values, both, the SPD device and electrical equipment connected to the line can result in damage.

Internal manipulation or the modification of the SPD device will invalidate the guarantee.

## DESCRIPTION OF THE SPD DEVICE

VP series conforms a group of modular protectors that allows their installation in any system of the electrical line (TT, TN, IT). They provide complete protection in common and differential mode. These protectors incorporate a dynamic disconnector to separate the SPD device from the line when the protection is not active. The actuation of this disconnector is indicated by a visual signalling signal.

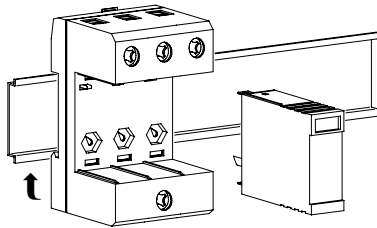

Frequency: 50/60 Hz  
 Operating temperature: -40° + 80° C  
 Relative humidity: 30-90 %  
 Relative inclination: 5°  
 Mounting: 35 mm DIN Rail  
 Protection degree: IP 20  
 Weight: 315 gr

Code	Un	Uc	Up	In	I <sub>max</sub>	t <sub>a</sub>	Signalling
41607	230 V	275 V	1,2 kV	20 kA	40 kA	< 25 ns	YES

The SPD has a commutated contact for remote signalling of the working state of the module.

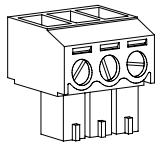

Technical features:

- AC: 125 V / 1 A
- DC: 125 V / 0,2 A

Cable section: 1,5 mm<sup>2</sup>

### MODULE STATE

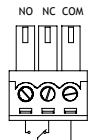

- Protection module → CORRECT

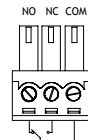

- Protection module → CHANGE

## INSTALLATION INSTRUCTIONS

It is very important for a correct protection to make the connections of the wires to VP device in V form (see scheme) and put the input and output lines as separated as possible. Never wind or tighten the cable in excess.

### TT, TN, IT SYSTEM (NOT recommended connection)

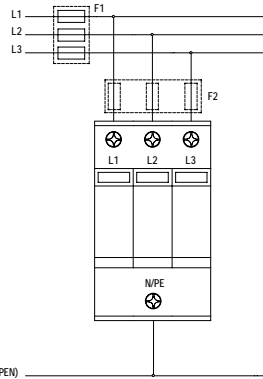

### TT, TN, IT SYSTEM (Recommended connection)

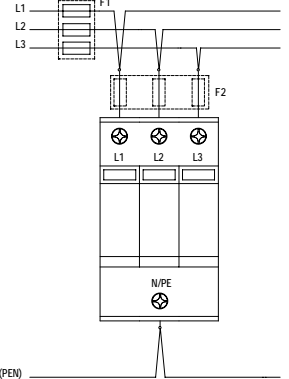

- Verify the line voltage measuring the voltage between L-N, L-G and L-L. Confirm that selected SPD is adequate to the electrical line where it is going to be installed. The value of U<sub>c</sub> must never be exceeded.
- Install the SPD device as close as possible to the equipment to be protected. Mount it in a safe way over the DIN rail.
- Earth connection: All the devices must be connected to earth by a cable from the appropriate terminals of the SPD to earth system of the installation.
- Neutral connection (if necessary): Try the length of the neutral wire to be as short as possible. Connect the neutral cable from the appropriate terminal of the SPD to the neutral system of the panel or the installation.
- Phase connection: Try the length of the wire to be as short as possible. Connect the phase wire from the specific terminal of the SPD to the protection device of this SPD (fuse or breaker).

If the distance between the protector and the equipment to be protected is higher than 10 meters, install an additional SPD protector close to the equipment to be protected.

## FUSES

In electrical schemes, F1 is the breaking component before the SPD protector. In some cases, it is necessary to install an additional fuse F2. To determinate the necessity of F2, it is necessary to check the value of F1. It must be verified that the value of F1 fuse that is installed is NOT higher than the value indicated in the graphic. In opposite case, it must be installed F2 fuse and it is recommended to have the value indicated in the graphic also.

- If F1 > 125 A gL/gG → F2 ≤ 125 A gL/gG
- If F1 ≤ 125 A gL/gG → NOT necessary to install F2

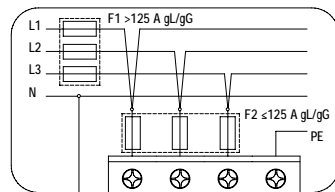
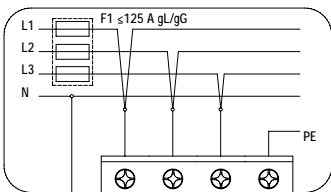

## DIMENSIONS

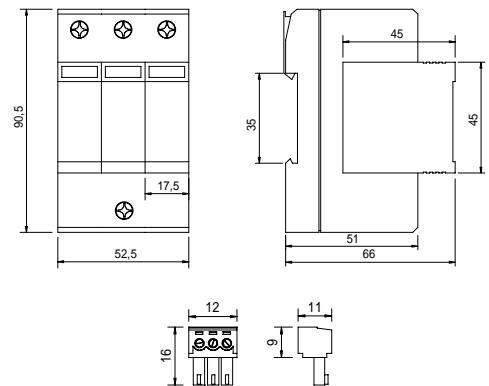

## MAINTENANCE

This SPD device for protection against transient overvoltages doesn't need specific maintenance. When the fail of the protection happens, the module state indication window changes to red colour. In this case, take out damaged module and change it for a new one.

## CABLE SECTION

	SOLID CABLE	FLEXIBLE CABLE
LINE cable section	6 - 16 mm <sup>2</sup>	6 - 25 mm <sup>2</sup>
NEUTRAL cable section	6 - 16 mm <sup>2</sup>	6 - 25 mm <sup>2</sup>
EARTH cable section	10 - 25 mm <sup>2</sup>	10 - 35 mm <sup>2</sup>

- Avoid loops in connection cable.
- Avoid sharps bends in the cables.